

$$\frac{\sin A}{Q} = \frac{\sin B}{R} = \frac{\sin C}{A} \quad R^2 = P^2 + Q^2 - 2PQ \cos B$$

$$\vec{R} = \vec{P} + \vec{Q} \quad F_x = F \cos \theta_x \quad F_y = F \cos \theta_y \quad F_z = F \cos \theta_z$$

$$F_x = F_h \cos \phi \quad \vec{F} = F_x \vec{i} + F_y \vec{j} + F_z \vec{k}$$

$$= F \sin \theta_y \cos \phi \quad = F (\cos \theta_x \vec{i} + \cos \theta_y \vec{j} + \cos \theta_z \vec{k})$$

$$F_y = F_h \sin \phi \quad = F \vec{\lambda}$$

$$= F \sin \theta_y \sin \phi \quad \vec{\lambda} = \cos \theta_x \vec{i} + \cos \theta_y \vec{j} + \cos \theta_z \vec{k}$$

$$\vec{P} \bullet \vec{Q} = P_x Q_x + P_y Q_y + P_z Q_z \quad M_x = yF_z - zF_y$$

$$M_y = zF_x - xF_z$$

$$M_z = xF_y - yF_x$$

$$\vec{M}_O = \vec{r} \times \vec{F} \quad \vec{P} \bullet \vec{P} = P_x^2 + P_y^2 + P_z^2 = P^2$$

$$\vec{M}_O = \vec{r}' \times \vec{F} = (\vec{r} + \vec{s}) \times \vec{F} = \vec{r} \times \vec{F} + \vec{s} \times \vec{F}$$

$$= \vec{M}_O + \vec{s} \times \vec{F}$$

$$\sum F_x = 0 \quad \sum F_y = 0 \quad \sum M_A = 0$$

$$\sum F_x = 0 \quad \sum F_y = 0 \quad \sum F_z = 0$$

$$\sum M_x = 0 \quad \sum M_y = 0 \quad \sum M_z = 0$$

$$\vec{P} \times \vec{Q} = (P_y Q_z - P_z Q_y) \vec{i} + (P_z Q_x - P_x Q_z) \vec{j} + (P_x Q_y - P_y Q_x) \vec{k} = \begin{pmatrix} \vec{i} & \vec{j} & \vec{k} \\ P_x & P_y & P_z \\ Q_x & Q_y & Q_z \end{pmatrix}$$

$$\vec{S} \bullet (\vec{P} \times \vec{Q}) = S_x (P_y Q_z - P_z Q_y) + S_y (P_z Q_x - P_x Q_z) + S_z (P_x Q_y - P_y Q_x)$$

$$= \begin{pmatrix} S_x & S_y & S_z \\ P_x & P_y & P_z \\ Q_x & Q_y & Q_z \end{pmatrix}$$

$$\sum M_y \bar{x}W = \sum x\Delta W = \int x dW \quad \sum M_x \bar{y}W = \sum y\Delta W = \int y dW$$

For lines:  $\bar{x}(\gamma La) = \int x(\gamma a) dL \quad \bar{x}L = \int x dL \quad \bar{y}L = \int y dL$

Centroid:  $\bar{x}A = \int x dA = \iint x dx dy = \int \bar{x}_{el} dA \quad \bar{y}A = \int y dA = \iint y dx dy = \int \bar{y}_{el} dA$

Pappas-Guldinus  $A = 2\pi \bar{y}L \quad V = 2\pi \bar{y}A$

Moments of Inertia  $I_x = \int y^2 dA \quad I_y = \int x^2 dA \quad J_0 = \int r^2 dA = I_y + I_x$

radius of gyration  $I_x = k_x^2 A \quad I_y = k_y^2 A \quad J_0 = k_0^2 A \quad \text{Parallel axis theorem: } I = \bar{I} + Ad^2$

Product of inertia  $I_{xy} = \int xy dA \quad I_{xy} = \bar{I}_{xy} + \bar{x}\bar{y}A$

$$x' = x \cos \theta + y \sin \theta \quad y' = y \cos \theta - x \sin \theta \quad I_{x'} = \frac{I_x + I_y}{2} + \frac{I_x - I_y}{2} \cos 2\theta - I_{xy} \sin 2\theta$$

$$I_{y'} = \frac{I_x + I_y}{2} - \frac{I_x - I_y}{2} \cos 2\theta + I_{xy} \sin 2\theta \quad I_{x'y'} = \frac{I_x - I_y}{2} \sin 2\theta + I_{xy} \cos 2\theta \quad (I_{x'} - I_{ave})^2 + I_{x'y'}^2 = R^2$$

$$I_{ave} = \frac{I_x + I_y}{2} \quad R = \sqrt{\left(\frac{I_x - I_y}{2}\right)^2 + I_{xy}^2} \quad I_{\max, \min} = I_{ave} \pm R \quad \tan 2\theta_m = -\frac{2I_{xy}}{I_x - I_y}$$

$r^2 \Delta m = \text{moment of inertia of the mass } \Delta m \quad I = k^2 m \quad k = \sqrt{I/m} \quad I_y = \int r^2 dm = \int (z^2 + x^2) dm$

$I_x = \int (y^2 + z^2) dm \quad I_z = \int (x^2 + y^2) dm \quad \text{Parallel axis theorem } I_x = \bar{I}_x + m(\bar{y}^2 + \bar{z}^2)$

$I_y = \bar{I}_y + m(\bar{z}^2 + \bar{x}^2) \quad I_z = \bar{I}_z + m(\bar{x}^2 + \bar{y}^2) \quad I = \bar{I} + md^2$

$$\sum \vec{F}_i = \sum m_i \vec{a}_i \quad \sum (\vec{r}_i \times \vec{F}_i) = \sum (\vec{r}_i \times m_i \vec{a}_i) \quad \vec{L} = \sum_{i=1}^n m_i \vec{v}_i \quad \dot{\vec{L}} = \sum_{i=1}^n m_i \dot{\vec{v}}_i = \sum_{i=1}^n m_i \vec{a}_i \quad \sum \vec{F} = \dot{\vec{L}}$$

$$\vec{H}_O = \sum_{i=1}^n (\vec{r}_i \times m_i \vec{v}_i) \quad \dot{\vec{H}}_O = \sum_{i=1}^n (\vec{r}_i \times m_i \vec{a}_i) \quad \sum \vec{M}_O = \dot{\vec{H}}_O$$

Center of Mass:  $m\vec{r}_G = \sum_{i=1}^n m_i \vec{r}_i \quad m\vec{v}_G = \sum_{i=1}^n m_i \vec{v}_i = \vec{L} \quad m\vec{a}_G = \dot{\vec{L}} = \sum \vec{F} \quad \vec{H}'_G = \sum_{i=1}^n (\vec{r}'_i \times m_i \vec{v}'_i)$

$$\dot{\vec{H}}'_G = \sum_{i=1}^n (\vec{r}'_i \times m_i \vec{a}'_i) = \sum_{i=1}^n (\vec{r}'_i \times \vec{F}_i) = \sum \vec{M}_G$$

$$T = \frac{1}{2} \sum_{i=1}^n m_i (\vec{v}_i \cdot \vec{v}_i) = \frac{1}{2} \sum_{i=1}^n m_i v_i^2 \quad T = \frac{1}{2} m \vec{v}_G^2 + \frac{1}{2} \sum_{i=1}^n m_i v_i'^2 \quad \vec{L}_1 + \sum_{t_1}^{t_2} \vec{F} dt = \vec{L}_2 \quad \vec{H}_1 + \sum_{t_1}^{t_2} \vec{M}_O dt = \vec{H}_2$$

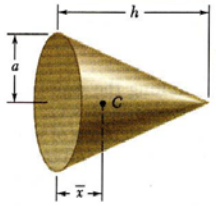
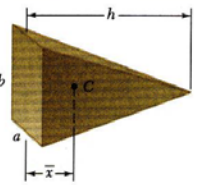
Cone		$\frac{h}{4}$	$\frac{1}{3} \pi a^2 h$
Pyramid		$\frac{h}{4}$	$\frac{1}{3} abh$

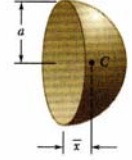
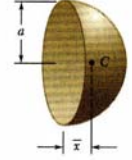
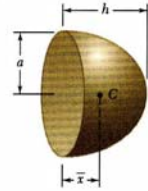
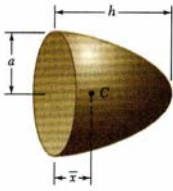
Shape		$\bar{x}$	Volume
Hemisphere		$\frac{3a}{8}$	$\frac{2}{3} \pi a^3$
Semiellipsoid of revolution		$\frac{3h}{8}$	$\frac{2}{3} \pi a^2 h$
Paraboloid of revolution		$\frac{h}{3}$	$\frac{1}{2} \pi a^2 h$

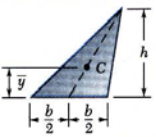
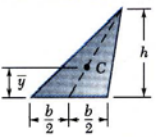
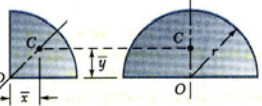
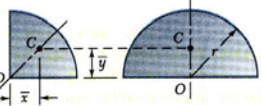
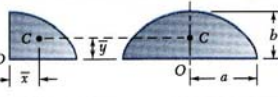
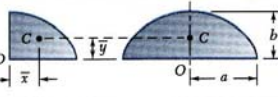
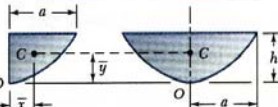
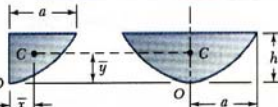
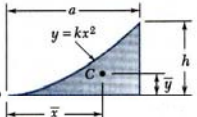
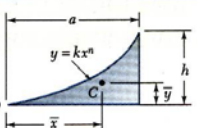
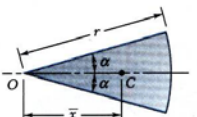
Shape		$\bar{x}$	$\bar{y}$	Area
Triangular area			$\frac{h}{3}$	$\frac{bh}{2}$
Quarter-circular area		$\frac{4r}{3\pi}$	$\frac{4r}{3\pi}$	$\frac{\pi r^2}{4}$
Semicircular area		0	$\frac{4r}{3\pi}$	$\frac{\pi r^2}{2}$
Quarter-elliptical area		$\frac{4a}{3\pi}$	$\frac{4b}{3\pi}$	$\frac{\pi ab}{4}$
Semielliptical area		0	$\frac{4b}{3\pi}$	$\frac{\pi ab}{2}$
Semiparabolic area		$\frac{3a}{8}$	$\frac{3h}{5}$	$\frac{2ah}{3}$
Parabolic area		0	$\frac{3h}{5}$	$\frac{4ah}{3}$
Parabolic spandrel		$\frac{3a}{4}$	$\frac{3h}{10}$	$\frac{ah}{3}$
General spandrel		$\frac{n+1}{n+2} a$	$\frac{n+1}{4n+2} h$	$\frac{ah}{n+1}$
Circular sector		$\frac{2r \sin \alpha}{3\alpha}$	0	$\alpha r^2$

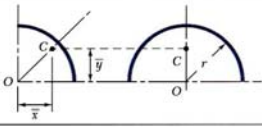
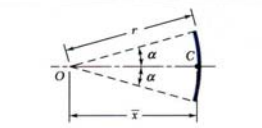
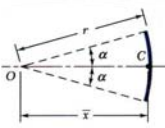
Shape		$\bar{x}$	$\bar{y}$	Length
Quarter-circular arc		$\frac{2r}{\pi}$	$\frac{2r}{\pi}$	$\frac{\pi r}{2}$
Semicircular arc		0	$\frac{2r}{\pi}$	$\pi r$
Arc of circle		$\frac{r \sin \alpha}{\alpha}$	0	$2\alpha r$

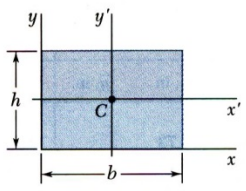
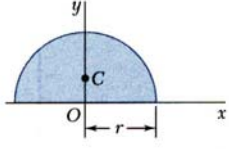
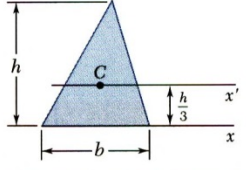
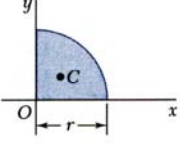
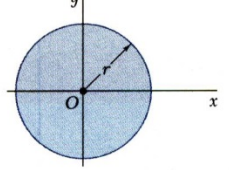
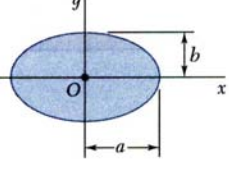
Rectangle		$\bar{I}_{x'} = \frac{1}{12}bh^3$ $\bar{I}_{y'} = \frac{1}{12}b^3h$ $I_x = \frac{1}{3}bh^3$ $I_y = \frac{1}{3}b^3h$ $J_C = \frac{1}{12}bh(b^2 + h^2)$	Semicircle		$I_x = I_y = \frac{1}{8}\pi r^4$ $J_O = \frac{1}{4}\pi r^4$
Triangle		$\bar{I}_{x'} = \frac{1}{36}bh^3$ $I_x = \frac{1}{12}bh^3$	Quarter circle		$I_x = I_y = \frac{1}{16}\pi r^4$ $J_O = \frac{1}{8}\pi r^4$
Circle		$\bar{I}_x = \bar{I}_y = \frac{1}{4}\pi r^4$ $J_O = \frac{1}{2}\pi r^4$	Ellipse		$\bar{I}_x = \frac{1}{4}\pi ab^3$ $\bar{I}_y = \frac{1}{4}\pi a^3b$ $J_O = \frac{1}{4}\pi ab(a^2 + b^2)$

$$\vec{r}_B = \vec{r}_A + \vec{r}_{B/A} \quad \dot{\vec{r}}_B = \dot{\vec{r}}_A + \dot{\vec{r}}_{B/A} \quad \ddot{\vec{r}}_B = \ddot{\vec{r}}_A + \ddot{\vec{r}}_{B/A}$$

$$\vec{v} = \frac{d\vec{r}}{dt} = \vec{\omega} \times \vec{r} \quad \vec{a} = \vec{\alpha} \times \vec{r} + \vec{\omega} \times \vec{\omega} \times \vec{r} = \vec{\alpha} \times \vec{r} - \omega^2 \vec{r} \quad \vec{a}_t = \vec{\alpha} \times \vec{r} \quad \vec{a}_n = -\omega^2 \vec{r}$$

$$\alpha = \frac{d\omega}{dt} = \frac{d^2\theta}{dt^2} = \omega \frac{d\omega}{d\theta} \quad \omega = \omega_0 + \alpha t$$

$$\theta = \theta_0 + \omega_0 t + \frac{1}{2}\alpha t^2$$

$$\omega^2 = \omega_0^2 + 2\alpha(\theta - \theta_0)$$

$$\text{rigid body } \vec{v}_B = \vec{v}_A + \vec{v}_{B/A} \quad \vec{v}_{B/A} = \vec{\omega} \times \vec{r}_{B/A} \quad v_{B/A} = r\omega \quad \vec{v}_B = \vec{v}_A + \vec{\omega} \times \vec{r}_{B/A}$$

$$\vec{a}_B = \vec{a}_A + \vec{a}_{B/A} \quad (\vec{a}_{B/A})_t = \vec{\alpha} \times \vec{r}_{B/A} \quad (a_{B/A})_t = r\alpha \quad (\vec{a}_{B/A})_n = -\omega^2 \vec{r}_{B/A} \quad (a_{B/A})_n = r\omega^2$$

$$\sum F_x = m\bar{a}_x \quad \sum F_y = m\bar{a}_y \quad \sum M_G = \bar{I}\alpha$$

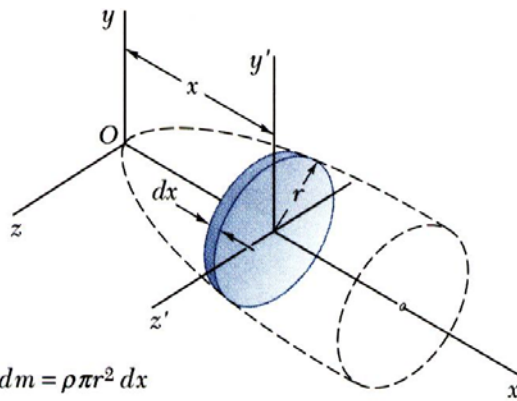

$$dm = \rho \pi r^2 dx$$

$$dI_x = \frac{1}{2} r^2 dm$$

$$dI_y = dI_{y'} + x^2 dm = \left(\frac{1}{4} r^2 + x^2\right) dm$$

$$dI_z = dI_{z'} + x^2 dm = \left(\frac{1}{4} r^2 + x^2\right) dm$$

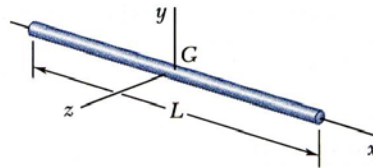

$$I_y = I_z = \frac{1}{12} mL^2$$

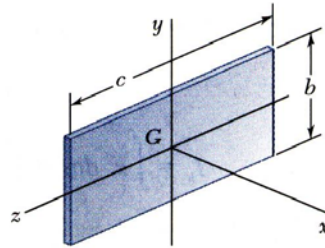

$$I_x = \frac{1}{12} m(b^2 + c^2)$$

$$I_y = \frac{1}{12} mc^2$$

$$I_z = \frac{1}{12} mb^2$$

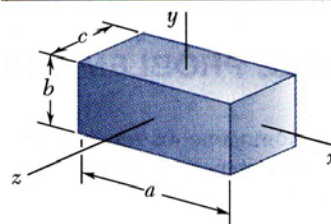

$$I_x = \frac{1}{12} m(b^2 + c^2)$$

$$I_y = \frac{1}{12} m(c^2 + a^2)$$

$$I_z = \frac{1}{12} m(a^2 + b^2)$$

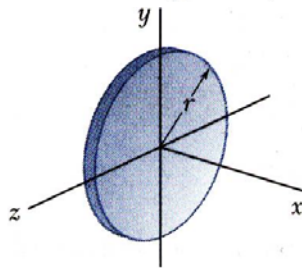

$$I_x = \frac{1}{2} mr^2$$

$$I_y = I_z = \frac{1}{4} mr^2$$

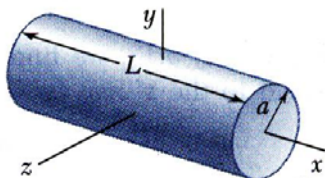

$$I_x = \frac{1}{2} ma^2$$

$$I_y = I_z = \frac{1}{12} m(3a^2 + L^2)$$

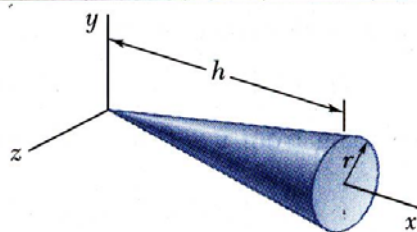

$$I_x = \frac{3}{10} ma^2$$

$$I_y = I_z = \frac{3}{5} m\left(\frac{1}{4} a^2 + h^2\right)$$

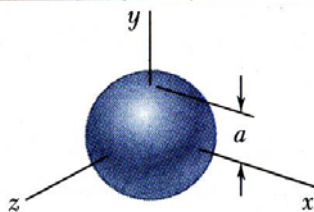

$$I_x = I_y = I_z = \frac{2}{5} ma^2$$